

Bridge Federation of Asia & Middle East



21st BFAME Championships

08 - 14 December, 2021



Daily Bulletin

Editor: Ron Tacchi

Bulletin 0

Wednesday 8th December 2021

On behalf of BFAME Council members and organizing Committee, it gives me great pleasure to convey our warm greetings to all participants, officials and delegates to the 21st BFAME Zonal Championships

All over the World, Zonal Championships constitute the pinnacle of bridge achievement for the best National Players and Teams and the “cream of the cream” who will have the fine privilege of representing their Country and Zone once they have qualified for the next World Championships which, this time, will take place in Salsomaggiore, Italy towards the end of March 22

Needless to say, that we are forced to hold this event during these difficult times where the whole world continues to suffer from this “wicked” Pandemic Covid 19; indeed, forced to hold these championships “on line” rather than “face to face” where we met, saw each other and socialized with each other. Throughout our discussions and exchanges, it became evident that “On-Line” encounters were the best way to hold this event; our prime concern and top priority has been (and is) to safeguard your health and save the hassle of travelling (with all its difficulties: Airline’s Regulations, Visas processes and Vaccinations)

We sincerely hope this will be the “one-time” exception and that we will meet soon in our next 22nd BFAME Zonal championships in one of our beloved countries and enjoy seeing you all, I hope you and your families will be in good health

On behalf of the BFAME Council members and organizing Committee, I wish you all the best of luck and enjoyment and hope to see the members of the eight qualifying teams in all four categories shortly in Salsomaggiore Italy.

Bahjat Al Majali
President, BFAME

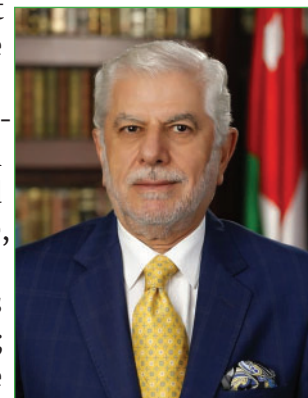

Dear Bridge Players–Dear Friends,

I am very pleased to be able to welcome the participating teams from Zone 4 to the BFAME Championships, where teams will seek to qualify for the World 2021 Team Championships to be held in Salsomaggiore Terme, Italy in the Spring next year.

We have all been living through a strange and frightening time in our history. Organised bridge seemed to come to a halt for a time, but we have developed new ways of playing, new regulations for online play which have enabled our Zonal Authorities to hold their Championships online rather than face to face.

I know that I can rely on your integrity, sense of fair play and good ethics as you participate in the BFAME Championship, and hope you will enjoy your bridge and the challenge of what I am sure will be an exciting tournament.

I look forward to welcoming the winning teams to Italy next March when we hope to meet again across the table.

Gianarrigo Rona
WBF President



Today's Schedule











Open Championship

Round 1 Match 1 7.30 (GMT)		Round 1 Match 2 11.00 (GMT)		Round 1 Match 3 13.30 (GMT)	
 India	 Saudi Arabia	 UAE	 India	 India	 Jordan
 Pakistan	 UAE	 Saudi Arabia	 Jordan	 UAE	 Bangladesh
 Bangladesh	 Jordan	 Pakistan	 Bangladesh	 Saudi Arabia	 Pakistan

Senior Championship

Round 1 Match 1 7.30 (GMT)		Round 1 Match 2 11.00 (GMT)		Round 1 Match 3 13.30 (GMT)	
 India	 Saudi Arabia	 UAE	 India	 India	 Jordan
 Pakistan	 UAE	 Saudi Arabia	 Jordan	 UAE	 Bangladesh
 Bangladesh	 Jordan	 Pakistan	 Bangladesh	 Saudi Arabia	 Pakistan

Women Championship

Round 1 Match 1 7.30 (GMT)		Round 1 Match 2 11.00 (GMT)		Round 1 Match 3 13.30 (GMT)	
 Jordan	 UAE	 Palestine	 Jordan	 Jordan	 India
 India	 Palestine	 UAE	 India	 Palestine	 UAE

Mixed Championship

Round 1 Match 1 7.30 (GMT)		Round 1 Match 2 11.00 (GMT)		Round 1 Match 3 13.30 (GMT)	
 India	 UAE	 Jordan	 India	 India	 Pakistan
 Pakistan	 Jordan	 UAE	 Pakistan	 Jordan	 UAE

General Instructions

1. Home & Visiting teams

When you log in to the RealBridge game (using the game link), you will find your team name written on one of the Tables.

All team members are required to sit at their table (all together / all team at same table) in Pairs N/S and E/W, later on, when we start the session, the software will automatically move the E/W pairs between the tables according to the schedule of play.

In the schedule of play you will find Home team (the team mentioned first) and Visiting team (the team mentioned second)

NO LINE-UP will be needed from the teams, the visiting team has to sit first at their table (in Pairs N/S and E/W), minimum 10 min before the official start time, and the Home team has the right to have a look at the visiting team and sit its pairs accordingly.

2. Time delay and hesitation

It is very important to know that the TDs have the tools to produce a board report which includes the time for each bid / play by each player, so please be bare that in mind when calling the TD for a possible hesitation or before denying it.

It is also very important to know that the TDs also have the tools to produce a session time report which includes the exact time taken by each player in a session, in case of time delay, the penalty will be given according to this report.

3. Headphones / Earphones

In order to minimize the noise in the venue as much as possible...

It is strongly recommended that each player has his own headphone / earphone which is connected to his device during play

Use the table chat / private chat as much as possible and don't use vocal chat.

Any vocal explanation will not be taken into the TD consideration in any case.

You need to be very careful when using the table chat as you might give an unauthorized information to your partner which could results in adjusted score by the TD

4. Kibitzers

Kibitzers are not allowed by any means at the playing venue or the RealBridge online playing room.

All players are required to immediately leave the playing area when they finish their session, players are also kindly asked to keep their seats and not roam around the playing area.

All the matches will be broadcasted via RealBridge kibitzer website...

<https://kibitz.realbridge.online/>

At the RealBridge kibitzer website, you can find the live broadcasted matches and also all the other matches scheduled for broadcast.

For security reasons, all broadcasted matches will be delayed by 30-45 min.

5. Smoking, Eating and Alcohol, Mobile and electronic devices

We must act as if we were playing these championships "live", therefore, the following is strictly forbidden during play:

Mobile phones and any other electronic devices, Mobile phones will be collected and there will be a regular check each session by the monitor.

Eating (even if only biscuits) or Drinking Alcohol

Smoking

Going to the WC without permission

Talking loudly during or at the end of any board if the player is unhappy about his/her partner's bid, hand play or defence.

Final Instructions

Welcome to the 21st BFAME championship 2021!

IMPORTANT LINKS

BFAME Website

<https://www.bridgewebs.com/bfame/>

Time table, Schedule of play, play links, Results and more ...

https://www.bridgewebs.com/cgi-bin/bwon/bw.cgi?club=bfame&pid=display_page41

Convention Cards

https://www.bridgewebs.com/cgi-bin/bwon/bw.cgi?club=bfame&pid=display_page47&sessid=662449186987538

General Instructions

https://www.bridgewebs.com/cgi-bin/bwon/bw.cgi?club=bfame&pid=display_page42&sessid=662449186987538

Head TD Corner & Review Form

https://www.bridgewebs.com/cgi-bin/bwon/bw.cgi?club=bfame&pid=display_page45&sessid=43754367897896

Kibitzer Website

<https://kibitz.realbridge.online/>

The 21st BFAME Championship will start Wednesday 8th December, we would like to stress on some important points.

Play Format

Open & Senior Teams: 6 teams (BAN, IND, JOR, PAK, KSA & UAE)

All teams will play 3 complete Round Robin, 15 matches in 5 days from 8-12 DEC.

The first and second Round Robin will be done according to pre-defined draw by the OC.

The third Round Robin will be done according to the team rank in the previous played 2 Round Robins.

After the Round Robin stage, the top 4 teams will qualify to the Semi-Final stage which will be as follows:

The top ranked team after the 3 complete Round Robin stage will chose its opponent in the semi-final match; opponent must be one of the teams ranked 3rd or 4th and the remaining 2 teams will play against each other

.The semi-final match will be played in 4 Sessions, 16 boards each in IMPs.

The final match between the semi-final winners will be played in 2 Sessions, 16 Boards each.

In all the knock out stages, there shall be a carry-over of only 0.5 IMP to the team who scored more VPs in the Round Robin stage.

The team ranked higher after the Round Robin stage will be the Home team in sessions 2 and 4 in the Semi-final match.

The team ranked lower after the Round Robin stage will be the Home team in sessions 1 and 3 in the Semi-Final match.

The team ranked higher after the Round Robin stage will be the Home team in session 2 in the Final.

Women Teams: 4 Teams (IND, JOR, PAL & UAE)

All teams will play 5 complete Round Robins, 15 matches in 5 days from 8-12 DEC.

The first 4 Round Robins will be done according to pre-defined draw by the OC.

The last Round Robin will be done according to the team rank in the previous played 4 Round Robins.

After the Round Robin stage, the top 2 teams will qualify to World championship and will play the final between each other on DEC. 13th, to determine the title winner.

Mixed Teams: 4 Teams (IND, JOR, PAK & UAE)

All teams will play 5 complete Round Robins, 15 matches in 5 days from 8-12 DEC.

The first 4 Round Robins will be done according to pre-defined draw by the OC.

The last Round Robin will be done according to the team rank in the previous played 4 Round Robins.

After the Round Robin stage, the top 2 teams will qualify to World championship and will play the final between each other on DEC. 13th, to determine the title winner.

Play Links

Already posted to the BFAME website with the dates, session number and category.

<https://www.bridgewebs.com/bfame/Play%20Links-BFAME.htm>

Will also be sent to the players' registered email addresses.

The game will be open to players to join 30 min before the official start time.

Home & Visiting teams

When you log in to the RealBridge game (using the game link), you will find your team name written in one of the Tables.

All team members are required to sit at their table (all together) in Pairs N/S and E/W, later on, when we start the session, the software will automatically move the E/W pairs between the tables according to the schedule of play.

The higher ranked team is the home team.

The visiting team has to sit first at their table (in Pairs N/S and E/W) and the home team has the right to have a look at the visiting team and sit its pairs accordingly.

Your Tournament Directors

Mr. Sudhir Aggrawal, Mr. Ihsan Qadir, Mr. Raad Etoom and Mr. Tarek Abdel Rahman will be your friendly Tournament Directors throughout.

Please feel free to contact us with any questions or concerns.

With best wishes for a wonderful event.

Bridge Federation of Asia & Middle East
BFAME SYSTEMS POLICY – Appendix 2

1. PREAMBLE

1. The objectives are to ensure that BFAME Championships can be properly operated and adequately administered, with a fair and equal chance for all competitors, while at the same time affording proper consideration to progress and innovation; to ensure that players are in no doubt as to what is expected of them with regard to preparation and filing of systems material for BFAME Championships.
2. Additions or amendments to this policy will normally be put into effect only after four months' notice.
3. References to High Card Points in this document are Milton Work Points.
4. In the following '**Weak**' means 9 points or less and '**Strong**' means 16 points or more.

2. POLICY

2.1 HUM Systems

For the purpose of this Policy, a Highly Unusual Method (HUM) means any System that exhibits one or more of the following features:

- a. By partnership agreement an opening call of Pass shows at least the values generally accepted for an opening bid of one, even if there are alternative weak possibilities
- b. By partnership agreement an opening bid at the one level may be weaker than pass.
- c. By partnership agreement an opening bid at the one level may be made with 7 high card points or less.
- d. By partnership agreement an opening bid at the one level shows either three cards or more, or two cards or less in a specified suit
- e. By partnership agreement an opening bid at the one level shows either three cards or more in one specified suit or three cards or more in another. **EXCEPTION:** one of a minor in a strong club or strong diamond system.

2.2 Classification of Systems

In order to facilitate recognition and handling, systems material will be identified by one or more of the following:

- i. a WBF colored sticker;
- ii. the appropriate named (hand printed or typed) color;
- iii. a check mark on a system card next to the appropriate color - in keeping with the following descriptions:

Green Natural methods

Blue Forcing Club/Forcing Diamond, where one club/one diamond is artificial, shows a hand with 13 high card points or more and is always forcing.

Red This category includes all systems that do not fall under the classifications of Green, Blue or Yellow (as defined herein).

Red 1 would be a system where one club shows one of three types - a natural club suit, a balanced hand of a specific range, or a Strong Club opener; or which uses specialized and artificial responses to an opening bid of one club.

Red 2 would be a system in which the basic one level methods (other than the no trump range and minimum suit-length requirements) vary according to position, vulnerability and the like; or a system that uses conventional 'weak' or 'multi-meaning' bids (with or without some weak option) in potentially contestable auctions, or a system where the opening bids are transfers to another suit.

Yellow Highly Unusual Methods ('HUM') as defined above.

2.3 Brown Sticker Conventions and Treatments

The following conventions or treatments are categorized as 'Brown Sticker':

- a. Any opening bid of two clubs through three spades that:
 - i. could be made on 9 high card points or less AND
 - ii. does not promise at least four cards in a known suit.

EXCEPTION: The bid always shows at least four cards in a known suit if it is weak. If the bid does not show a known four card suit it must show a hand with 13 high card points or more.

(Explanation: Where all the weak meanings show at least four cards in one known suit, and the strong meanings show a hand with 13 high card points or more, it is not a Brown Sticker Convention.)

EXCEPTION: a two-level opening bid in a minor showing a weak two in either major, whether with or without the option of strong hand types containing 16 high card points or more, or with equivalent values. Defensive measures are permitted for opponents as in 6 below.

- b. An overcall of a natural opening bid of one of a suit that does not promise at least four cards in a known suit.

EXCEPTION: A natural overcall in no trumps.

EXCEPTION: any cue bid suit that shows a strong hand.

EXCEPTION: a jump cue bid in opponent's known suit that asks partner to bid 3NT with a stopper in that suit.

- c. Any 'weak' two-suited bids at the two or three level that may by agreement be made with three cards or fewer in one of the suits.
- d. Psychic bids protected by system or required by system.
- e. None of the foregoing restrictions pertain to conventional defenses against forcing, artificial opening bids or defenses against 'Brown Sticker' or HUM conventions.
- f. For the avoidance of doubt an opening bid of one club which may be made on a doubleton or singleton club and which is ostensibly natural and non-forcing should be regarded as natural and not artificial.

Additional to the classification of systems in 2.2 above, any partnership using one or more 'Brown Sticker' conventions must indicate this alongside its system classification.

2.4 Encrypted Signals

Additional to the restrictions on bidding methods and conventions above, players may not use signaling methods by which the message or messages conveyed by the signals are hidden from the declarer because of some key available only to the defenders (i.e. encrypted signals are not allowed).

2.5 Random Openings

It is forbidden to open hands which, by agreement, may contain fewer than 8 high card points and for which no further definition is provided.

3. Systems allowed at BFAME Championships

The use of both HUM systems and 'Brown Sticker' systems are prohibited.

Special Online Policies

1. General

All players must be present at the playing spot determined by the local NBO and approved by BFAME and will play under the supervision of a monitor appointed by the BFAME in agreement with the local NBO.

WBF 20 VP “continues scale” will be used in the RR Stage

KO stage—if any - will be calculated in IMPs

Butler ranking will be posted after each RR session.

In the event that there is confusion, lack of clarity, or a difference in the interpretation of one of the technical clauses in these regulations, the interpretation of the Head TD is the final interpretation of this confusion / wording.

In the event there is confusion, lack of clarity, or a difference in the interpretation of one of the non-technical items in these regulations, the interpretation of the Chairman of the organizing Committee shall be final interpretation of this confusion / wording.

Playing with mobile phones are completely restricted, only Laptops / tablets shall be allowed.

It is the responsibility of each NBO to provide a good and stable internet connection in the playing area for the players, BFAME monitor, BFAME Officials and BFAME IT.

Two Surveillance cameras with an internet connection and zoom capability controlled by the TD will be placed inside the playing area to monitor it.

It is the responsibility of each NBO to provide playing table’s screens in the playing area, in case needed by the appointed monitor.

2. Alert

All ALERTABLE bids must be self-alerted (press the alert button before making the bid). And give a full writing disclosure of the bidding, vocal explanation won’t be taken into the TD consideration.

NOTE: - Players will not be allowed to alert their partner’s bid, only self-alert will be allowed and the written explanation will be shown to both opponents but not to partner.

3. Undo

Undoes are allowed only during bidding and according to the followings:

The undo button is activated from the beginning.

Click the undo button to stop the bidding.

Call the TD

No Action from any party will be taken before the arrival of the TD.

The TD will instruct the opponents whether to accept the undo or not, the TD will accept only the obvious miss-click requests but not the change of mind requests.

The TD will keep counting the undoes for each player, only 2 undoes are allowed for each player during one session.

If the opponents accept—before the TD arrival - , bidding continue. but all parties forfeit their rights for any kind of rectification later on.

If the opponents don’t accept—before the TD arrival - , bidding stops and the TD decide what is to be done.

The TDs reserve the rights to adjust the score of the board for any unauthorised information might arise from using the undo process.

Undo is not allowed under any circumstances during playing the deals and if a player request an undo during play, the TD has to be summoned immediately to take an action and he might adjust the score.

Bridge Federation of Asia & Middle East

BFAME Systems Policy – Appendix 4: Psychic Bidding

Psychic Calls and similar actions based upon partnership understandings.

The Laws of Duplicate Contract Bridge 2017 permit a player to make a psychic call “provided that such call is not based upon a partnership understanding”. If a call is based upon a partnership understanding it ceases to be psychic. In its minute of 30th August 2000 the WBF Laws Committee ruled that a partnership understanding exists when the frequency of occurrence is sufficient for the partner of the player who makes the call to take his awareness of psychic possibilities into account, whether he does so or not; or, of course, it may be a matter explicitly agreed. There are also relevant statements in the WBF Code of Practice. Such an understanding must be disclosed beforehand.

The understandings in question are to be disclosed in World Championships and other tournaments conducted under the auspices of the WBF in accordance with the following requirements:

1. Explicit agreements that psychic calls are expected, or providing systemic protection for them, are classified as Brown Sticker. One example of the kind is when, third in hand at favorable vulnerability, a player is expected to open the bidding on anything at all.
2. Understandings whereby from time to time there may be gross violations of the normal meanings of calls, and where the nature or type of violation can be anticipated, must also be disclosed on the convention cards. The understandings may be explicitly agreed or they may have developed from partnership experience or mutually shared knowledge not available to opponents. They must be listed on the card amongst the conventions that may call for special defense and the supplementary sheets must give full detail of situations in which these violations may occur and of the relevant partnership practices and expectations. Subject to satisfactory disclosure methods of this kind are permissible in any category of event.
3. It continues to be the case that random psychics may occur as the laws allow, without warning, so long as these can no more be anticipated by the partner than by the opponents.
4. Similar principles apply in the case of psychic actions in defenders’ play of the cards.

Taster 1

To get myself back into the habit of watching play on RealBridge I kibbitzed the first taster session. It was probably a reawakening for some of the players or maybe their first time. The session was only eight boards but at least two of the deals provided some excitement.

Board 1. Dealer North. None Vul.

<p>♠ AKJ2 ♥ AK943 ♦ QJ84 ♣ —</p>		<p>♠ Q1095 ♥ QJ87 ♦ A10 ♣ AQJ</p>	<p>♠ 763 ♥ 106 ♦ K7 ♣ 1098764</p>
	<p>♠ 84 ♥ 52 ♦ 96532 ♣ K532</p>		

Your mission here is to get to the grand slam, BUT you must get to the right one. Seven Hearts is not a good grand slam (except in the Hamman definition, i.e. it makes) as it requires the diamond finesse, in other words it is only a 50% grand slam, not good odds. Seven Spades has many more chances—we will revisit the odds of this contract later.

As we have learnt at our mother's knee, 'play in the 4-4 fit' but like many things our mothers told us it is easier to say than to do. What should West bid after partner opens a strong no-trump? I think a lot depends on how you play the responses to Stayman, if you are allowed to reply 2NT with both majors then that is the method I would adopt, as if you are lucky enough to find partner with both majors you can easily elect to play in spades. If, however, partner has to respond Two Hearts with both majors then it is exceedingly probable that the spade fit will not be found. So if this is your method then transferring to hearts and later showing the spades could prove superior.

Of the twelve times the board was played the contract was played in spades only twice. Once after a Stayman response of 2NT, which gave rise to the only spade grand slam, and the other after a trans-

fer to hearts and then subsequently showing spades and so the small slam was reached. Here is the auction that led to the spade grand slam:

West	North	East	South
<i>Said</i>		<i>Attef</i>	
—	Pass	1NT	Pass
2♣	Pass	2NT*	Pass
3♥*	Pass	3♠	Pass
5♣*	Pass	5♦*	Pass
5♥*	Pass	6♣*	Pass
7♠	All Pass		
2NT both majors			
3♥ transfer to spades			
5♣ Exclusion Blackwood			
5♦ 1 or 4			
5♠ Heart queen?			
6♣ Yes and a club feature			

Well bid, though we will gloss over the play, fortunately for declarer the diamond finesse was onside. The same fortune was available to three pairs who bid the grand slam but in hearts. Six pairs arrived in the small slam and somehow one pair languished in game, writing +510 in one's scorecard is never a warm feeling.

So how good a contract is Seven Spades? I think it is solid if there is not a void in either major. You only need to ruff two clubs to amass thirteen tricks. On the most testing lead of a trump win in the West hand and play a second round to East. Ruff a club, return with the ace of diamonds and ruff another club. A heart to the queen and draw the remaining trumps and claim.

Board 7. Dealer South. All Vul.

<p>♠ KJ865 ♥ 7 ♦ AKJ10862 ♣ —</p>		<p>♠ A2 ♥ AJ103 ♦ Q73 ♣ Q876</p>	<p>♠ Q109 ♥ K86542 ♦ 4 ♣ J94</p>
	<p>♠ 743 ♥ Q9 ♦ 95 ♣ AK10532</p>		

Another slam hand—the great shuffler was working overtime for an eight-board set. The first question is whether one should be in the grand slam, to which I reply with a definite yes. I estimate the chances of success to be in excess of 70%, not only are you certain if the spades break 3-3 or 4-2 with a doubleton queen but also, if the ♦9 is singleton, then any 3-3 or 4-2 spade break can be coped with and if you are not fortunate in the trump suit then you can deal with a 4-2 spade break when it is North who holds the doubleton.

The next question is how does one bid it. This is a much more difficult question. It happened only once over the twelve tables. Those pairs who were subject to a heart overcall by North were unlikely to make it even to the small slam. I must confess I do not see an obvious way of developing the auction after North's interference—sometimes pre-empts work—that is why we do them. Here is the auction of the pair who managed to reach the grand slam.

West	North	East	South
<i>Rasel</i>		<i>Zamam</i>	
—	—	—	Pass
1♦	Pass	1♥	2♣
2♠	Pass	3♣	Double
3♠	Pass	4♦	Pass
5♣*	Pass	5♠*	Pass
7♦	All Pass		

I am assuming that 5♣ was Exclusion Blackwood and that 5♠ showed two aces, though I do not understand why the response was not 5NT showing two aces and the queen of trumps, but it was not of great import to West as now the grand slam could be bid. Two grand slams and each of them using 5♣ as Exclusion Blackwood, I will wager a large sum of money that it will not happen again in the next Taster Session.

Taster 2 Bonus

I was unable to watch the second Taster Session but the following day I took a look at the deals and was pleasantly surprised to find yet another possible grand slam among the eight boards. To decide if it was a 'good' grand slam is a harder question. Five of the twenty tables reached the heights and all five succeeded. Seven pairs attained the small slam and the rest bar one stayed in game. That remaining pair somehow came to rest in 4♣ which did not score well against 2140 for the successful grand slam..

Board 5. Dealer North. N/S Vul.

	♠ AQJ	
	♥ 102	
	♦ 4	
	♣ AQ96543	
♠ 6542		♠ K1093
♥ 753		♥ Q96
♦ K98653		♦ Q102
♣ —		♣ 1087
	♠ 87	
	♥ AKJ84	
	♦ AJ7	
	♣ KJ2	

I quite liked this auction

West	North	East	South
	<i>Ahmed</i>		<i>Mohammad</i>
	1♣	Pass	1♥
Pass	3♣	Pass	3♦
Pass	3NT	Pass	4♣
Pass	4♠*	Pass	4NT
Pass	5♠*	Pass	5NT
Pass	6♣*	Pass	7♣
All Pass			
4♠	cue-bid		
5♠	2 keycards plus queen		
6♣	no outside king		

Three Clubs may be a slight overbid but it does describe the hand and gets it off your chest. Once South admitted to club support North could cue-bid and South then followed up with Blackwood and when all the keycards were present he could attempt the grand slam.

Now we come to the question of how to play the contract and its chances of success. With a 2-1 trump break you will make the contract whenever the hearts are 3-3 or the queen is doubleton. If that fails to materialise you can fall back on the spade finesse which I estimate to be nearly 60%. If the trumps are 3-0 then you need to find the heart suit good for four tricks, this boosts the total percentage to about 70 and so fair odds for the grand slam. And that is without counting on the chance of a spade lead which one of the declarers was fortunate enough to receive.

21st BFAME Championships Rosters

Open		Women	
Bangladesh		India	
Captain	Amir Ali Rana	Captain	Subhash Chandra Gupta
Player	Md Zahid Hossain	Player	Puja Batra
Player	Mohammad Maula Al Mamun	Player	Asha Sharma
Player	SK Aminur Rahman	Player	Bharati Dey
Player	BM Mahmud Hossain	Player	Vasanti Shah
Player	Ali Ahammed	Player	Feroza Chothia
Player	Md Anisuzzaman	Player	Aparna Sushil Sain
India		Jordan	
Captain	Debasish Ray	Captain	Ramzi Najeeb Goussous
Player	Keyzad Anklesaria	Player	Yasmin M.A.Khattak
Player	Rajeshwar Tewari	Player	Dimah Omar Al-taher
Player	Sumit Mukherjee	Player	Mays Wahib Albittar
Player	Debabrata Majumder	Player	Hanan Khalil Al salem
Player	Sandeep Thakral	Player	Bana Ibrahim Taher
Player	Jaggy Shivdasani	Player	Alia M A Rida
Jordan		Palestine	
Captain	Zafer Jarrar	Captain	Laila Haddadin
Player	Zafer Jarrar	Player	Nawar Hashem
Player	Sakher Malkawi	Player	Hanan Albitar
Player	Amr Nimer	Player	Silvia Hayk Kh Harbedian
Player	Laith Jarrar	Player	Fadia Najjar
Player	Clement Maamarbach	Player	May Abogharbieh
Player	Aida Abu Jaber	Player	Laila Haddadin
Pakistan		U.A.E	
Captain	Kashif Ali Qureshi	Captain	Manju law
Player	Kashif Ali Qureshi	Player	Manju law
Player	Hasnat Mahmood	Player	Rubinder Kochar
Player	Khalid Mohiuddin	Player	Vandana Darshan Valrani
Player	Muhammad Mubashir Puri	Player	Anshu Agarwal
Player	Yasser Rahim	Player	Rupinder kaur Walia
Player	Arslan Mansoor	Player	Kumkum Kumar
Saudi Arabia			
Captain	Bassem Afioni		
Player	Bassem Afioni		
Player	Abdul hakim Sahab		
Player	Mohammed Hassan Badawoud		
Player	Mohamed Ali Azem		
Player	Hussam Sallout		
Player	--		
U.A.E			
Captain	Hesham Attef Abdelmonaem		
Player	Hesham Attef		
Player	Akiel H N Almadi		
Player	Hazem Ghoneim		
Player	Khaled Hassan Abdelatief		
Player	Abdelrahim Mehilba		
Player	Mohamed Said Elsayed		

21st BFAME Championships Rosters

Seniors		Mixed	
Bangladesh		India	
Captain	Mohammad Azizul Haque	Captain	Vinay Desai
Player	Mohammad Azizul Haque	Player	Kiran Nadar
Player	ATM Moazzem Hussain	Player	Bachiraju Satyanarayana
Player	Khodoker Mazharul Haque	Player	Marianne Karmarkar
Player	Md Jahirul Haque	Player	Sandeep Karmarkar
Player	DM Hanzala	Player	Himani Khandelwal
Player	Sayeed Ahmed	Player	Rajeev Khandelwal
India		Jordan	
Captain	Ramaratnam Krishnan	Captain	Marwan Ghanem
Player	Ashok Kumar Goel	Player	Marwan Ghanem
Player	K R Venkatraman	Player	Sireen Barakat.
Player	Anil P. Padhye	Player	Samer Alrawashdeh
Player	Rajesh A. Dalal	Player	Farah Tambulat
Player	Subrata Saha	Player	Mona Alzaben
Player	Sukamal Das	Player	Ghassan Ghanem
Jordan		Pakistan	
Captain	Ghassan Ghanem	Captain	Ahsan Javed Qureshi
Player	Ghassan Ghanem	Player	Ahsan Javed Qureshi
Player	Omran Abdallah Abudhaim	Player	Zia Hyder Naqi
Player	Jamal Abdul Jalil	Player	Aamir Ishaq
Player	Zead Shariha	Player	Rubina Agha
Player	Jack Karouta	Player	Samira Fancy
		Player	Neelofar Aslam
Pakistan		U.A.E.	
Captain	Kamran Ibrahim	Captain	Nermeen Qasim
Player	Azhar Hamid	Player	Nermeen Qasim
Player	Muhammad Ghalib Bandesha	Player	Humayun Sumar
Player	Masood Mazhar	Player	Timur Edis
Player	Iftikhar Baqai	Player	Elvan Edis
Player	Zakir Mahmood	Player	Marie Hindie
Player	Kamran Ibrahim	Player	Amr Mekky
Saudi Arabia			
Captain	Tareg Ahmad Alyafi		
Player	Salem Sabali		
Player	Tareg Ahmad Alyafi		
Player	Adnan Ali Mosly		
Player	Ayman Tarek Al Safadi		
Player	Reda Salama		
Player	Mujahid R Y		
U.A.E			
Captain	Ahmed Almidfa		
Player	Ahmed Almidfa		
Player	Valrani Darshan		
Player	Sanjay Satyasadhan Dutta		
Player	Arun Chopra		
Player	Hussein Adam Ali		
Player	Ravishankar Bhat		